





## USER MANUAL

### SOLAR TRAIL CAMERA

**Models:**  
SOLAR  
& comparable\*

 [support.spypoint.com](https://support.spypoint.com)

 1-888-779-7646

 [tech@spypoint.com](mailto:tech@spypoint.com)

**v1.8**

\* Specs and features may differ across comparable models.  
Refer to website or packaging for full details.



**THANK YOU FOR CHOOSING A SPYPOINT PRODUCT.**

This manual will guide you through all the features of your device so that you will get optimal use out of your SPYPOINT product. Our priority is to provide outstanding customer service. If you need support for your product, please contact the SPYPOINT technical support or visit our website.



**CONTACT**

-  1-888-779-7646
-  tech@spypoint.com
-  www.spypoint.com

**ABOUT US**

 GG Telecom’s mission is to offer products that are easy to use, innovative, affordable and of exceptional quality. Our SPYPOINT products are mainly used for hunting and residential/commercial surveillance. They are distributed and shipped all over the world and the market never stops growing. Prosperous and respected, GG Telecom is a company that constantly keeps abreast of new technologies and listens to its customers to deliver cutting-edge products with practical solutions that improve hunting and outdoor activities.

**JOIN THE SPYPOINT COMMUNITY**

-  facebook.com/SPYPOINT
-  twitter.com/SPYPOINTcamera
-  youtube.com/SPYPOINTtrailcam

Available for all SPYPOINT trail cameras models, this incredible tool for hunters enable you to manage all your cameras & photos.



**Online camera & photo management system**

Create your **FREE** START-UP account!

- ✓ **AUTOMATICALLY SORT YOUR PHOTOS**  
Drag & drop your photos to sort them by date.
- ✓ **ACCESS YOUR PHOTOS**  
from anywhere & never worry about backups or storage space.
- ✓ **SHARE YOUR PHOTOS**  
with your hunting partners, friends & family.
- ✓ **GEOTAG YOUR TRAIL CAMERAS**  
Locate your cameras faster & never misplace them in the woods again.
- ✓ **TAKE CONTROL OF YOUR CELLULAR CAMERAS**  
Change settings, get status updates, notifications & GPS location (compatible models only).

<b>Components</b> .....	<b>4</b>
<b>Specifications</b>	
SOLAR .....	<b>6</b>
<b>Power</b> .....	<b>7</b>
<b>Memory card &amp; Busy LED</b> .....	<b>8</b>
<b>Settings</b> .....	<b>9</b>
<b>Installation &amp; Mounting bracket</b> .....	<b>13</b>
<b>File transfer to a computer</b> .....	<b>14</b>
<b>Available accessories</b> .....	<b>15</b>
<b>Troubleshooting</b> .....	<b>16</b>
<b>Warranty &amp; Repair</b> .....	<b>17</b>
<b>Regulation</b> .....	<b>18</b>



- 1 Solar pannel
- 2 LEDs
- 3 Photo lens
- 4 Test light
- 5 Cable lock hole
- 6 Detection lens

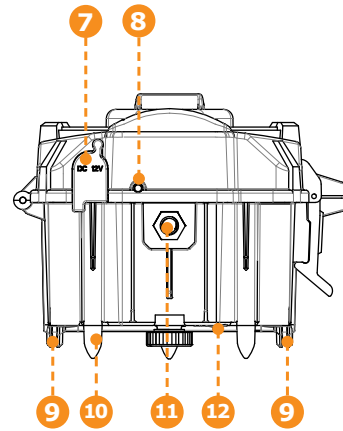

- 7 12V Jack
- 8 Microphone
- 9 Slot for installation strap
- 10 BUSY LED
- 11 Tripod mount
- 12 Battery case

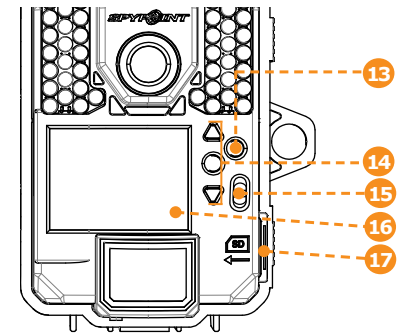

- 13 OK button
- 14 Navigation buttons
- 15 ON / OFF Switch
- 16 Viewing screen
- 17 SD card slot

# Components



<b>1</b>	Solar Panel	Allow to charge the internal battery.
<b>2</b>	LEDs	Night lighting to obtain black and white photos and videos.
<b>3</b>	Photo lens	Image sensor and infrared filter.
<b>4</b>	Test light	Flashes in TEST mode when there is detection and flashes 30 seconds in PHOTO/VIDEO mode to allow the user to leave without being photographed or recorded.
<b>5</b>	Cable lock hole	Allows the user to install a CL-6FT cable lock, sold separately.
<b>6</b>	Fresnel lens	Expands the detection area and increases the sensitivity of the camera's motion sensor.
<b>7</b>	12V power jack	This camera can be powered from an external 12-volt DC input such as a 12V battery or a 12V adapter, each sold separately.
<b>8</b>	Microphone	Records sound in video mode.
<b>9</b>	Slot for installation strap	Allows the user to install the camera using the installation strap included.
<b>10</b>	BUSY LED	Lights up when TEST mode is activated.
<b>11</b>	Tripod mount	Standard ¼-20" tripod mount.
<b>12</b>	Battery case	Case for AA batteries or a rechargeable lithium battery pack.

<b>13</b>	OK button	Allows the user to make a selection.
<b>14</b>	Navigation buttons	Buttons to set the camera.
<b>15</b>	On-Off Switch	Allows the user to turn on/off the camera.
<b>16</b>	Viewign screen	Allows the user to access the main menu and view photos/videos.
<b>17</b>	SD card slot	An SD card is required to record photos/videos.

## SOLAR

### Photo recording

Photo resolution	12 MP
File format	JPG
Time lapse mode	Intervals from 1m to 24h
Multi-shot mode	Up to 6 photos per detection
Stamp <b>(only on photos)</b>	Date, time, temperature (°C/°F) and moon phase
Capture mode	Color by day, black and white by night

### Video recording

Video resolution	1280 x 720 (HD 720p)
File format	AVI
Sequence length	Adjustable from 10 to 90 s
Capture mode	Color by day, black and white by night

### Audio

Sound recording (automatically recorded in video mode)	Mono
--	------

### Memory storage

Support	<ul style="list-style-type: none"> <li>•Internal memory: none</li> <li>•External memory : SD/SDHC card (up to 32 GB)</li> </ul>
---------	---

### Viewing

Built-in screen	ACL 2.0"
-----------------	----------

### Power source

Internal rechargeable battery

### Optional power sources

Alkaline or lithium batteries	6 x AA
Lithium battery pack	Rechargeable battery pack (LIT-09/LIT-C-8)
External (12V jack)	12V battery (KIT6V-12V, KIT-12V, BATT-12V) or 12V adapter (AD-12V)

### Detection system

Motion sensor	PIR
Detection angle	40°
Detection range	Adjustable from 5 to 80 ft
Trigger speed	0.07 sec
Delay between each detection	Adjustable from Instant to 30 min

### Night time illumination system

LEDs	42 LEDs
Flash range	< 100 ft
Exposure	Automatic infrared level adjustment

### Optical field of view

40°

### Dimensions

3.8" W X 6.9" H X 3.9" D

### Recommendations

Operating temperature	(-30 °C to + 50 °C) (-22 °F to +122 °F)
Storage temperature	(-40 °C to + 60 °C) (-40 °F to +140 °F)

First, look at the internal battery percentage in the DETECTION TEST menu. If the percentage is low and the battery logo is not green, you will need to charge the camera for 24-48 hours before use. While charging, make sure the camera is turned off and the solar panel is facing down so it does not interfere with the USB charging process.

Plug the cable from the 12V port at the bottom of the camera and connect it to a USB port. (ex. USB power adaptor or a computer that will stay awake while charging) Once plugged, the screen will turn on and it will show the charging battery level for 10 seconds. Press the OK button once more to see the battery level reappear. (2017 models only)

If the battery level is yellow or red, charge the internal battery of the camera for 24-48 hours before use. While plugged in, the Busy LED will turn on if the camera needs to be charged and turn off when charged enough for use.

- When a single line remains, the camera will continue to take photos. If a video is being recorded and the battery level reaches 0%, the camera saves the file before shutting down.
- If the power of the internal battery becomes insufficient, the camera will shut down. Once the battery has been charged sufficiently by the solar panel, the camera will automatically turn on leaving the settings untouched.
- An optional power source can be added as a backup to the internal rechargeable battery for maximum protection.
- You need at least 50% of the solar panel cleared for maximum performance.
- Make sure that there are no objects obstructing the solar panel, that it is not shaded by unwanted obstacles and/or foreign material.

## OPTIONAL POWER SOURCES

### AA BATTERIES

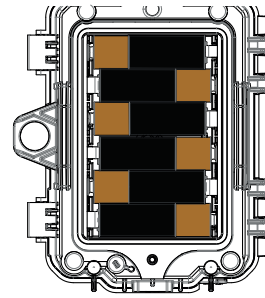

This camera can be powered by 6 AA batteries (1.5V). The use of alkaline or lithium batteries is recommended.

 To ensure maximum performance of the camera and prevent battery leak, we recommend the use of new batteries. Make sure to insert each battery with the correct polarity. (Negative or flat end against the metal spring plate) Do not mix battery type - use ALL alkaline or ALL lithium. Do not mix old and new batteries. Rechargeable AA batteries are not recommended as the lower voltage they produce can cause operational issues.

### LITHIUM BATTERY PACK

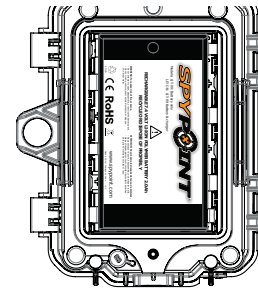

This camera can be powered by a rechargeable lithium battery pack LIT-09/LIT-C-8 (sold separately). This type of battery is less affected by cold temperatures and lasts up to 3 times longer than an alkaline batteries.

### EXTERNAL (12V)

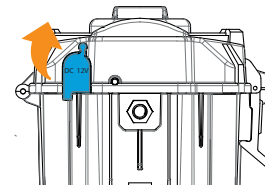

This camera can also be powered by an external 12-volt DC input such as a 12-volt battery (KIT-12V, BATT-12V or KIT6V/12V) or a 12-volt adapter (AD-12V), sold separately.

# Memory card / "BUSY" LED



## MEMORY CARD

A memory card is required to record photos and videos. The camera is compatible with SD/SDHC memory cards, up to 32 GB capacity (sold separately).

When the camera is turned on and no memory card is used, the camera beeps. In TEST mode, the screen displays "Insert Memory Card".

Here is a table of the approximate number of photos and length of videos that can be recorded with different memory card capacities. Many photo and video resolutions are noted, see those corresponding to the camera.

**Note:** This SPYPOINT camera is equipped with continuous file recording. When the memory card is full, the camera will continue to record photos or videos by deleting the first recorded files.

	4 GB	8 GB	16 GB	32GB
<b>Photo</b>				
10 MP	1900	3800	7600	15200
11 MP	1700	3400	6700	13400
12 MP	1600	3200	6300	12600
<b>Video</b>				
1280 x 720	40 min	1h20	2h40	5h20

## INSERTING THE MEMORY CARD

Before inserting or removing a memory card, always turn off the camera to prevent loss or damage of the photos already recorded. Also make sure that the switch on the side of the card is not in the LOCK position.

Insert an SD/SDHC memory card (up to 32 GB capacity) in the card slot with the label side facing upward. The card is inserted correctly when a click is heard.

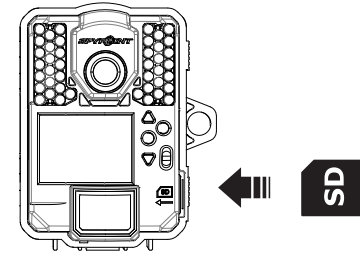

 We suggest to format your SD card if it's been in another electronic device to make sure you will have the maximum capacity of your memory card.

## REMOVING THE MEMORY CARD

Lightly press the memory card into the camera once to pop it out of the slot and remove it.

## BUSY LED

The BUSY light is located at the back of the camera and is covered by a rubber cap. In order to see the BUSY light, the rubber cap has to be removed. It is a diagnostic tool. It lights up when the camera starts, when the camera records a file and in TEST mode at the same time as the test light (located in front of the camera).





# Settings

Use the ↑ and ↓ buttons to navigate in the interface and modify the selection, the OK button to select and the ↶ button to return to the previous menu.

**START CAMERA**  
 Allows the user to start the camera in either, **PHOTO**, **VIDEO** or **TIME LAPSE** mode. When a mode is selected, the test light in front of the camera will flash for 30 seconds and a countdown will appear on the screen to allow the user to leave the area without being photographed.

**DETECTION TEST**  
 Allows the user to test the detection system of the camera. When the **DETECTION TEST** mode is selected, no photo or video is recorded. Walk perpendicularly in front of the camera. When the camera detects a movement, the busy light and the test light blink to indicate that normally, a photo or video would have been recorded. If the system does not detect the movement, increase the detection distance using the "Sensitivity" option in the settings menu. Realigning the camera can also be required. In **TEST** mode, it is possible to take a photo by pressing the OK button. The photo is saved and appears in the **VIEW** mode.

**VIEW**  
 Allows the user to view or delete recorded photos and videos on the camera screen.

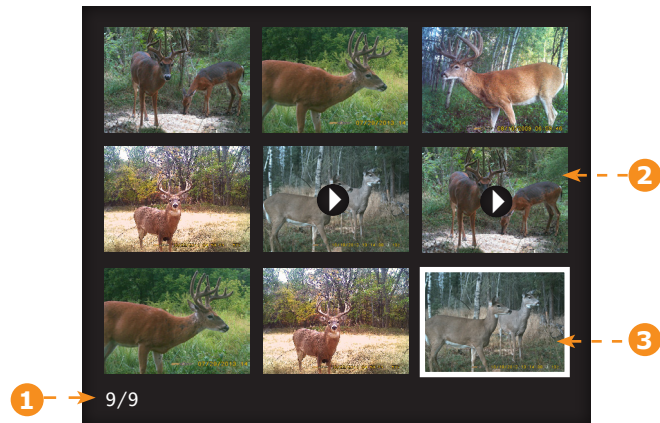

- 1 Selected photo / total number of photos
- 2 The play icon indicates that this element is a video
- 3 The white outline indicates which photo is selected

### Viewing with the screen of the camera:

When the **VIEW** mode is selected, the latest photos or videos recorded appear as thumbnails on the screen. Press ▲ or ▼ to navigate this page, and press OK to view a photo in large format. To view next or previous large photo, press ▲ or ▼. Press back to return to the thumbnail view.

When a large photo is opened, press OK to view the different options available:

Play:	Allows the user to play or pause the video on the screen (this option is available only for videos).
Zoom:	Allows the user to zoom in or out.
Date and time:	Allows the user to view the date and time printed on the photo.
Protect:	Allows the user to protect a photo or video to prevent it from being deleted by selecting "Erase All".
Erase:	Allows the user to erase the photo or the video seen on the screen from the memory card.
Erase all:	Allows the user to erase from the memory card all stored photos and videos, with the exception of protected files.
Format:	Allows the user to format the memory card and delete all protected photos and videos.
Exit:	Allows the user to exit the menu and return to the viewing screen.

**SETTINGS**  
 Allows the user to the different settings on the camera. From **PHOTO**, **VIDEO**, **TIME LAPSE** or **GENERAL** settings

# Settings



## PHOTO SETTINGS

Sets the options of the PHOTO mode.

### Recommended settings

The camera can be configured for **usage in trails**. This situation usually presents low activity level, fast subjects and a small number of photos is expected. These settings increase the chances of capturing animals that follow each other.

The camera can also be configured for **usage at a feeder's site**. This situation usually presents high activity level, slow subjects and a large number of photos is expected. These settings moderate the number of photos taken while capturing overall activity on feeder's site.

Here is a table showing the suggested settings for each situation:

	Trail	Feeder
Delay	Instant	5 min
Multi-shots	1	2-3

 When these recommended settings are not adapted to the situation, battery life can be affected.

### Delay: (Instant/10s/1m/3m/5m/10m/15m/30m)

Allows the user to choose the time interval between each detection before the camera records the next photo. A longer delay minimizes the number of photos taken and maximizes the battery life. A shorter delay maximizes the number of photos taken but requires more battery power. The shorter times interval are recommended when the camera is used for security purposes.

### Multi-shot: (1/2/3/4/5/6 consecutive shots)

Takes up to 6 consecutive shots at each detection, with a 10-second delay between each photo. This option allows the user to get up to 6 photos from different angles when the camera is in PHOTO mode.



## TIME LAPSE SETTINGS

Sets the options of the TIME LAPSE mode.

### Interval: (From 1m to 24h)

Allows the camera to take photos at regular preset intervals. For example, if "5m" is selected in the TIME LAPSE mode, the camera takes a photo every 5 minutes even if there is no detection. This option allows the user to obtain photos of game outside the detection range of the camera.

**Note:** The TIME LAPSE mode only applies for photos, not videos. When the TIME LAPSE mode is selected, the DELAY option and the MULTI-SHOT mode are disabled.



## VIDEO SETTINGS

Sets the options of the VIDEO mode.

### Delay: (Instant/10s/1m/3m/5m/10m/15m/30m)

Allows the user to choose the time interval between each detection before the camera records the next video. A longer delay minimizes the number of videos taken and maximizes the battery life. A shorter delay maximizes the number of videos taken but requires more battery power. The shorter times interval are recommended when the camera is used for security purposes.

### Video length: (10s/30s/60s/90s)

Allows the user to select the duration of the recording when the camera is set in VIDEO mode.

### Photo first:

When this option is enabled, a photo is taken immediately before each video.

**Note:** The file name of the photo corresponds to the digit before the video file name. For example, if the name of the photo is PICT001, the name of the video will be PICT002.

# Settings



## GENERAL SETTINGS

Sets the general options of the camera.

---

### Device name

Allows naming the camera with the electronic keyboard to identify it clearly. This option is particularly useful for users with more than one camera.

---

### Language: (English/Français/Deutsch)

Allows the user to select a language for the camera menus.

---

### Date format: (MM/DD/YY, DD/MM/YY)

Allows the user to set the date as Month/Day/Year or as Day/Month/Year.

---

### Time format: (12H/24H)

Allows the user to set to standard time or military time.

---

### Date:

Allows the user to set the date

---

### Time:

Allows the user to set the time

---

### Sensitivity: (Low/Medium/High)

Allow the user to choose the sensitivity of the motion sensor.

The camera will only detect sources of heat in movement. Make sure to have the least possible objects in front of the camera during the positioning. This prevents the camera of taking photos when oriented towards the sun while an object moves in front of the camera (e.g. a branch).

---

---

### Quality: (Normal/High)

Allow the user to set the photo quality.

---

### Info on photos: (Yes/No)

Allows the user to have date, time, temperature and moon phases printed on the photos.



---

### Start time:

Allows the user to set the start time of the motion detector.

---

### Stop time:

Allows the user to set the stop time of the motion detector.

---

---

### Night mode:

Allows the user to set the best option for photos.

	OPTIMAL MODE	IR-BOOST MODE	BLUR REDUCTION MODE
Battery life	★★★★★	★★★★★	★★★★★
Flash range	★★★★★	★★★★★	★★★★★
Blur reduction	★★★★★	★★★★★	★★★★★

\* Available for photos only

---

### About the device:

Allows the user to displays system information:

- Software version number
- Hardware version number
- Model number

---

### Factory reset:

Allows the user to restore the device to its original state.

# Installation & Mounting bracket



## INSTALLATION

### Recommended installation height:

The camera should be installed at the same height as the animal's mid-body.

### Ideal installation for quality pictures & videos:

The targeted animal should be 25 feet / 7.5m away from the camera for a better field of view.

To get brighter pictures at night, you should have elements in the background to reflect back the IR flash to the camera.

Note that the camera should not directly be facing the sun to avoid back lighting and false detection.

Make sure the front of the camera is free of any obstructions. The area of installation should be cleared from branches or bushes. These could be responsible for triggering false detections when combined with heat, reflections and/or wind. Setting the sensitivity level of the camera too high can also result in false detections by unwanted movement.

## MOUNTING BRACKET

To remove the camera from the mounting bracket:

1. Push the tab to release the camera from the mounting bracket.
2. Remove the camera.

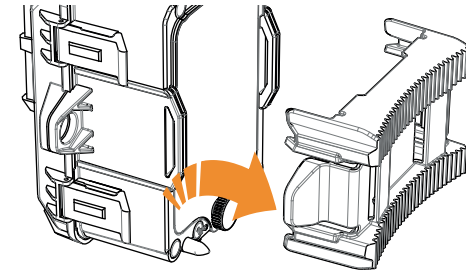

## INSTALLATION WITH THE SUPPLIED STRAP

Use the mounting bracket or the camera slot for installation strap to fix the camera.

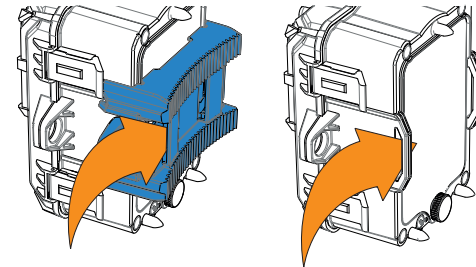

The dimensions of the strap (included) is 1" X 60".

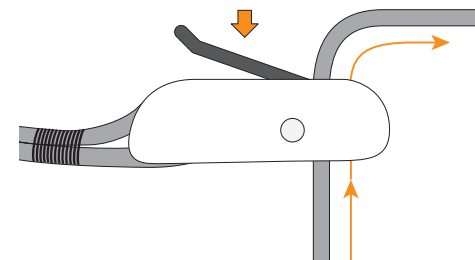

# File transfer to a computer

To transfer photos/videos to a computer:

- Turn OFF the camera.
- Remove the SD card from the camera.
- Insert the SD card into the computer slot, or use a memory card adaptor.
- The computer will detect the card and install the driver automatically.



## For a PC

Click on "My Computer" or «This PC» on your Desktop

Locate your device under "Removable Disk" and then click to access it. Then click on "DCIM" and "100DSCIM" to find all recorded photos and videos.

Select the photos you want to copy. The easiest way is to select them all by clicking on the Home tab and the Select all on the right-hand side. (You can also press Ctrl and the 'A' key, or click the Edit menu and choose select all in other versions of Windows)

Click the Copy icon on the left-hand side of the ribbon (or hold Ctrl and press C). [NOTE: If you don't want to select all photos, hold down the Ctrl key and click on the photos you do want to select before clicking the Copy icon]

Navigate to the folder in which you would like to store your images, or create a new folder by click the New Folder button in the ribbon. (You can also press Ctrl-Shift-N together to create a new folder, or right-click in some empty space in the Pictures folder and choose New, then from the next menu: Folder)

Type a name for your new folder, press Enter and then double-click on the folder to open it.

From the Home tab, choose Paste (or hold Ctrl and press V). The photos will be copied into the new folder.

## For a Mac

Click the Finder icon in the Dock.

Locate your device under the Devices tab and then click to access it. Then click on "DCIM" and "100DSCIM" to find all recorded photos and videos.

Click Edit on the toolbar running along the top of the screen and then press Select All to highlight every single images on the device. Select All is also achievable by pressing the ⌘ and A key simultaneously on your keyboard.

Alternatively, if you do not wish to import all, you can individually highlight the images you would like to transfer by holding ⌘ and clicking the file-name.

Click Edit once again and then Copy (or ⌘ and C) to copy the highlighted images.

Navigate to the folder in which you would like to store your images, or create a new folder by right-clicking and pressing CTRL simultaneously, then select New Folder from the menu.

Click Edit and then Paste (or ⌘ and V) to copy your chosen images from your device to the selected folder.

Images may take several minutes to transfer depending on the file size and the amount of images you are importing.

Once your images have transferred, click the Eject icon situated alongside the name of your device and then unplug the device from your Mac.



**Lithium battery pack & charger**  
#LIT-C-8, Rechargeable lithium battery pack and AC charger with charge indicator light. Fits all SPYPOINT cameras.



**12V DC Power cable**  
#CB-12FT, 12 ft power cable with alligator clips at one end to connect a 12V battery to a camera.



**Steel security box**  
#SB-200, Steel box to secure the camera against theft. It also protects it from breakage caused by bears or other animals. Fits all SOLAR 42 LED SPYPOINT cameras.



**Camera mount**  
#MA-360, Adjustable mounting arm, fits all cameras that have a standard 1/4-20" tripod mount. It can rotate 360° and tilt approx +/- 90°. Also available in black.



**Rechargeable 12V battery, charger & housing kit**  
#KIT-12V, 12-volt 7.0Ah rechargeable battery with a water resistant ABS plastic case, AC charger, 12 ft power cable (#PW-12FT) and carrying strap included. Compatible with all SPYPOINT products equipped with a 12V power jack.



**12-volt Adaptor**  
#AD-12V, AC adaptor (6V to 12V). Powers the camera from an electrical outlet.



**Cable lock**  
#CL-6FT, 6 ft cable lock fits all SPYPOINT cameras.



**SD Memory card 16GB**  
#SD-16GB, SDHC UHS-1 memory card 16 GB, ultra high speed Class 10.

To obtain more information on other available accessories, go to  
[www.spypoint.com](http://www.spypoint.com)

# Troubleshooting



Issue	Possible solutions
Impossible to turn on the camera	<ul style="list-style-type: none"> <li>• Verify if there are batteries in the camera.</li> <li>• Verify if the batteries are correctly installed.</li> <li>• Install the latest update (available on <a href="http://www.spy-point.com">www.spy-point.com</a> under SUPPORT section).</li> <li>• Replace alkaline batteries or recharge the lithium battery pack.</li> </ul>
The screen of the camera turns off	<ul style="list-style-type: none"> <li>• The camera may be set to PHOTO or VIDEO mode and the screen turns off after a period of 30 seconds in order to preserve battery life.</li> <li>• The camera automatically resets itself to PHOTO or VIDEO mode (depending of the latest mode used or selected) after 2 minutes of inactivity on the main menu.</li> <li>• To return to the screen, turn off the camera and turn it on again.</li> </ul>
The camera beeps	<ul style="list-style-type: none"> <li>• Insert a memory card.</li> </ul>
The camera does not respond	<ul style="list-style-type: none"> <li>• Remove the batteries and reinstall them.</li> <li>• Replace alkaline batteries or recharge the lithium battery pack.</li> </ul>
Impossible to take photos/videos	<ul style="list-style-type: none"> <li>• Verify if there are batteries in the camera.</li> <li>• Replace alkaline batteries or recharge the lithium battery pack.</li> <li>• Verify if the camera is turned on.</li> </ul>
Red light in front of the camera blinks	<ul style="list-style-type: none"> <li>• Camera is set in TEST mode.</li> <li>• Camera is set in PHOTO or VIDEO mode. The red light in front of the camera flashes for 30 seconds to allow the user to leave without being photographed or recorded.</li> </ul>
Camera take black photos / videos	<ul style="list-style-type: none"> <li>• Verify the battery level to see if battery power is full as the flash will stop operating near the end of the battery life specially if you're doing a video.</li> <li>• Verify that there's something within the flash range to reflect the infrared back to the camera.</li> <li>• If you're not sure if the flash is working properly, test the camera in a dark. to see if you're able to have a black &amp; white pictures or videos.</li> </ul>

Photos / videos appear dark at night	<ul style="list-style-type: none"> <li>• For best result, make sure the subject is within the ideal flash range. Subjects may appear too dark at greater distances.</li> <li>• Pictures taken with a short delay between them (ex Delay:Instant or Muthishot) them may appear darker than others due to the quick response and rapid retriggering of the camera, allowing less time for the flash to fully recharge before firing again.</li> </ul>
Photos are blurry	<ul style="list-style-type: none"> <li>• Low lighting conditions and fast moving subjects, may produce streaks on the photo, try setting the "Night mode" to "BLUR" to reduce the motion blur.</li> </ul>
No person/animal on photos	<ul style="list-style-type: none"> <li>• Sunrise or sunset can trigger the sensor. Camera must be re-orientated.</li> <li>• At night, the motion detector may detect beyond the range of the IR illumination. Reduce sensibility setting.</li> <li>• Small animals may trigger the unit. Reduce sensibility setting and/or raise height of camera.</li> <li>• Motion detector may detect animals through foliage.</li> <li>• If a person or animal moves quickly, it may move out of the camera's field of view before the photo is taken. Move the camera further back or redirect the camera.</li> <li>• Make sure the mounting post or tree is stable and does not move.</li> </ul>
Error message	Possible solutions
Insert memory card	The use of a memory card is required to record photos and videos.
Card error	The camera cannot access the memory card. <ul style="list-style-type: none"> <li>• Turn off the camera and turn it on again</li> <li>• Remove the memory card and insert it again.</li> <li>• Verify if the gold contacts are clean.</li> <li>• Format the memory card.</li> </ul>
Low battery	Appears on the screen just before the camera turns off. Recharge the batteries or insert new ones. Always verify the battery level before using the camera.
No image	There are no files to view. Verify if the memory card contains photos/videos.
Protected file	It is impossible to delete the file because it is protected. To delete this file and all the others, just format the memory card.



# Warranty & Repair



## LIMITED WARRANTY

This SPYPOINT product designed by GG Telecom, is covered by a one (1) year warranty on material and workmanship starting from the original date of purchase. The sales receipt is the client's proof of purchase and must be presented if warranty service is needed. This warranty will be honored in the country of purchase only.

This GG Telecom warranty does not apply: (a) to consumable parts, including but not limited to batteries, which performance is designed to decrease over the course of time; (b) to damage caused by misuse, use with another product, neglect, accidents, liquid contact, fire, earthquake or any other external cause; (c) to GG Telecom products that have been purchased online from an unauthorized dealer; (d) to products that have had any modification or tampering; (e) to cosmetic damage including but not limited to scratches and broken plastic; (f) to damage caused by operating the GG Telecom product outside of GG Telecom's recommendations.

## INSTRUCTIONS FOR REPAIR SERVICE

GG Telecom will repair the product or replace it at its discretion with an equivalent product without charge if covered by the warranty described previously. The shipping fees for an item sent will be assumed by the customer. GG Telecom will then pay for the return of the product covered by the warranty.

For a product not covered by the warranty, the repair will be subject to a reasonable charge and the customer will also assume all shipping costs.

**IMPORTANT: Under no circumstances will GG Telecom accept returned products without a RMA number. (Return Material Authorization) It is essential to contact GG Telecom before making a return.**

1. Before sending a product for repair, please contact GG Telecom technical support team at 1-888-779-7646 or tech@spypoint.com as most issues can be solved over the phone or by mail.
2. If a product needs to be sent, an RMA number will be given to authorize the return of the product and for future reference.
3. The original receipt or a copy must be sent along with the package.
4. The RMA number must be written on the outside of the package and sent to:

CANADA  
GG Telecom  
330 de la Jacques-Cartier  
Victoriaville, QC  
G6T 1Y3

États-Unis  
GG Telecom  
3000 Gannett Avenue, Suite 2  
Des Moines, Iowa  
50321

The customer is liable for loss or damage to the product that may occur during the transport to GG Telecom. We recommend the use of a traceable method of shipping to ensure protection.

[WWW.SPYPOINT.COM](http://WWW.SPYPOINT.COM)

## FCC REGULATIONS



FCC Part 15

This equipment has been tested and found to comply with the limits for a Class B digital device, pursuant to Part 15 of the Federal Communications Commission (FCC) rules. These limits are designed to provide reasonable protection against harmful interference in a residential installation. This equipment generates, uses and can radiate radio frequency energy and, if not installed and used in accordance with the instructions, may cause harmful interference to radio communications. However, there is no guarantee that interference will not occur in a particular installation. If this equipment does cause harmful interference to radio or television reception, which can be determined by turning the equipment off and on, the user is encouraged to try to correct the interference by one or more of the following measures:

- Reorient or relocate the receiving antenna.
- Increase the separation between the equipment and receiver.
- Connect the equipment into an outlet on a circuit different from that to which the receiver is connected.
- Consult the dealer or an experienced radio/TV technician for help.

Changes or modifications to this equipment not expressly approved by the party responsible for compliance could void the user's authority to operate the equipment. This device complies with Part 15 of the FCC rules. Operation is subject to the following two conditions: (1) this device may not cause harmful interference, and (2) this device must accept any interference received, including interference that may cause undesired operation.